

# Safety-door Switch D4NS

## Multi-contact, Labor-saving, Environment-friendly, Next-generation Safety-door Switch

- Lineup includes three contact models with 2NC/1NO and 3NC contact forms and MBB models in addition to the previous contact forms 1NC/1NO, and 2NC.
- M12-connector models are available, saving on labor and simplifying replacement.
- Standardized gold-clad contacts provide high contact reliability.
- Applicable to both standard loads and microloads.
- Free of lead, cadmium, and hexavalent chrome, reducing the burden on the environment.

**Note:** Be sure to read the “Safety Precautions” on page A-12 and the “Precautions for All Safety Door Switches” on page A-2.



## Model Number Structure

### ■ Model Number Legend

#### Switch

D4NS-□□□  
1 2 3

##### 1. Conduit/Connector size

- 1: Pg13.5 (1-conduit)
- 2: G1/2 (1-conduit)
- 3: 1/2-14NPT (1-conduit)
- 4: M20 (1-conduit)
- 5: Pg13.5 (2-conduit)
- 6: G1/2 (2-conduit)
- 7: 1/2-14NPT compatible (2-conduit model with M20 conduit size includes an M20-to-1/2-14NPT conversion adapter)
- 8: M20 (2-conduit)
- 9: M12 connector (1-conduit)

##### 2. Built-in Switch

- A: 1NC/1NO (slow-action)
- B: 2NC (slow-action)
- C: 2NC/1NO (slow-action)
- D: 3NC (slow-action)
- E: 1NC/1NO (MBB contact)
- F: 2NC/1NO (MBB contact)

#### Operation Key

D4DS-K□  
1

##### 1. Operation Key Type

- 1: Horizontal mounting
- 2: Vertical mounting
- 3: Adjustable mounting (Horizontal)
- 5: Adjustable mounting (Horizontal/ Vertical)

**Note:** An order for the head part or the switch part alone cannot be accepted. The Operation Key is sold separately.

# Ordering Information

## ■ List of Models



### Switches (Operation Keys are sold separately.)

| Type                      | Contact configuration   |   | Conduit opening/Connector                         | Model    |
|---------------------------|-------------------------|---|---|----------|
| 1-Conduit                 | Slow-action             | 1NC/1NO   | Pg13.5  | D4NS-1AF |
|                           |                         |   | G1/2  | D4NS-2AF |
|                           |                         |   | 1/2-14NPT   | D4NS-3AF |
|                           |                         |   | M20   | D4NS-4AF |
|                           |                         | 2NC   | Pg13.5  | D4NS-1BF |
|                           |                         |   | G1/2  | D4NS-2BF |
|                           |                         |   | 1/2-14NPT   | D4NS-3BF |
|                           |                         |   | M20   | D4NS-4BF |
|                           |                         | 2NC/1NO   | Pg13.5  | D4NS-1CF |
|                           |                         |   | G1/2  | D4NS-2CF |
|                           |                         |   | 1/2-14NPT   | D4NS-3CF |
|                           |                         |   | M20   | D4NS-4CF |
|                           |                         | 3NC   | Pg13.5  | D4NS-1DF |
|                           |                         |   | G1/2  | D4NS-2DF |
|                           |                         |   | 1/2-14NPT   | D4NS-3DF |
|                           |                         |   | M20   | D4NS-4DF |
|                           | Slow-action MBB contact | 1NC/1NO   | Pg13.5  | D4NS-1EF |
|                           |                         |   | G1/2  | D4NS-2EF |
|                           |                         |   | 1/2-14NPT   | D4NS-3EF |
|                           |                         |   | M20   | D4NS-4EF |
| 2NC/1NO                   |                         | Pg13.5  | D4NS-1FF  |          |
|                           |                         | G1/2  | D4NS-2FF  |          |
|                           |                         | 1/2-14NPT   | D4NS-3FF  |          |
|                           |                         | M20   | D4NS-4FF  |          |
| 2-Conduit                 | Slow-action             | 1NC/1NO   | Pg13.5  | D4NS-5AF |
|                           |                         |   | G1/2  | D4NS-6AF |
|                           |                         |   | M20, includes M20-to-1/2-14NPT conversion adapter | D4NS-7AF |
|                           |                         |   | M20   | D4NS-8AF |
|                           |                         | 2NC   | Pg13.5  | D4NS-5BF |
|                           |                         |   | G1/2  | D4NS-6BF |
|                           |                         |   | M20, includes M20-to-1/2-14NPT conversion adapter | D4NS-7BF |
|                           |                         |   | M20   | D4NS-8BF |
|                           |                         | 2NC/1NO   | Pg13.5  | D4NS-5CF |
|                           |                         |   | G1/2  | D4NS-6CF |
|                           |                         |   | M20, includes M20-to-1/2-14NPT conversion adapter | D4NS-7CF |
|                           |                         |   | M20   | D4NS-8CF |
|                           |                         | 3NC   | Pg13.5  | D4NS-5DF |
|                           |                         |   | G1/2  | D4NS-6DF |
|                           |                         |   | M20, includes M20-to-1/2-14NPT conversion adapter | D4NS-7DF |
|                           |                         |   | M20   | D4NS-8DF |
|                           | Slow-action MBB contact | 1NC/1NO   | Pg13.5  | D4NS-5EF |
|                           |                         |   | G1/2  | D4NS-6EF |
|                           |                         |   | M20, includes M20-to-1/2-14NPT conversion adapter | D4NS-7EF |
|                           |                         |   | M20   | D4NS-8EF |
| 2NC/1NO                   |                         | Pg13.5  | D4NS-5FF  |          |
|                           |                         | G1/2  | D4NS-6FF  |          |
|                           |                         | M20, includes M20-to-1/2-14NPT conversion adapter | D4NS-7FF  |          |
|                           |                         | M20   | D4NS-8FF  |          |
| 1-Conduit, with connector | Slow-action             | 1NC/1NO   | M12 connector                                     | D4NS-9AF |
|                           |                         | 2NC   |   | D4NS-9BF |
|                           | Slow-action MBB contact | 1NC/1NO   |   | D4NS-9EF |

**Note:** 1. The recommended models for equipment and machinery being exported to Europe are those with an M20 or Pg13.5 conduit sizes, and for North America, the recommended models are those with a 1/2-14NPT conduit sizes.  
 2. Resin is used as the material for the D4NS housing and head. Use the metal D4BS Safety-door Switch for applications requiring greater mechanical strength.

Safety Door Switches  
D4NS

## Operation Keys

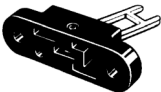
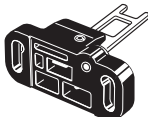
| Type   | Model   |
|--|---------|
| Horizontal mounting<br>                       | D4DS-K1 |
| Vertical mounting<br>                         | D4DS-K2 |
| Adjustable mounting (Horizontal)<br>          | D4DS-K3 |
| Adjustable mounting (Horizontal/Vertical)<br> | D4DS-K5 |

## Specifications

### Standards and EC Directives

- Conforms to the following EC Directives:
  - Machinery Directive
  - Low Voltage Directive
  - EN50047
  - EN1088
  - GS-ET-15

### Approved Standards

| Agency              | Standard                              | File No.          |
|---------------------|---------------------------------------|-------------------|
| TÜV Product Service | EN60947-5-1 (approved direct opening) | (See note 1.)     |
| UL (See note.)      | UL508, CSA C22.2 No.14                | E76675            |
| CQC (CCC)           | GB14048.5                             | 2003010305077 330 |

- Note:**
- Consult your OMRON representative for details.
  - Approval for CSA C22.2 No. 14 is authorized by the UL mark.
  - Ask your OMRON representative for information on approved models.

### Approved Standard Ratings

#### TÜV (EN60947-5-1), CCC (GB14048.5)

| Item                              | Utilization category | AC-15 | DC-13  |
|-----------------------------------|----------------------|-------|--------|
| Rated operating current ( $I_e$ ) |                      | 3 A   | 0.27 A |
| Rated operating voltage ( $U_e$ ) |                      | 240 V | 250 V  |

**Note:** Use a 10-A fuse type gI or gG that conforms to IEC60269 as a short-circuit protection device. This fuse is not built into the Switch.

#### UL/CSA (UL508, CSA C22.2 No. 14)

##### A300

| Rated voltage | Carry current | Current |       | Volt-amperes |        |
|---------------|---------------|---------|-------|--------------|--------|
|               |               | Make    | Break | Make         | Break  |
| 120 VAC       | 10 A          | 60 A    | 6 A   | 7,200 VA     | 720 VA |
| 240 VAC       |               | 30 A    | 3 A   |              |        |

##### Q300

| Rated voltage | Carry current | Current |        | Volt-amperes |       |
|---------------|---------------|---------|--------|--------------|-------|
|               |               | Make    | Break  | Make         | Break |
| 125 VDC       | 2.5 A         | 0.55 A  | 0.55 A | 69 VA        | 69 VA |
| 250 VDC       |               | 0.27 A  | 0.27 A |              |       |

## ■ Characteristics

|   |             |   |        |
|---|-------------|---|--------|
| Degree of protection (See note 3.)            |             | IP67 (EN60947-5-1)<br>(This applies for the Switch only. The degree of protection for the key hole is IP00.)                                    |        |
| Durability<br>(See note 4.)                   | Mechanical  | 1,000,000 operations min.   |        |
|   | Electrical  | 500,000 operations min. for a resistive load of 3 A at 250 VAC (See note 5.)<br>300,000 operations min. for a resistive load of 10 A at 250 VAC |        |
| Operating speed                               |             | 0.05 to 0.5 m/s   |        |
| Operating frequency                           |             | 30 operations/minute max.   |        |
| Direct opening force (See note 6.)            |             | 60 N min.   |        |
| Direct opening travel (See note 6.)           |             | 10 mm min.  |        |
| Contact resistance                            |             | 25 mΩ max. (initial value)  |        |
| Minimum applicable load (See note 7.)         |             | Resistive load of 1 mA at 5 VDC (N-level reference value)   |        |
| Rated insulation voltage (U <sub>i</sub> )    |             | 300 V   |        |
| Protection against electric shock             |             | Class II (double insulation)  |        |
| Pollution degree (operating environment)      |             | 3 (EN60947-5-1)   |        |
| Impulse withstand voltage (EN60947-5-1)       |             | Between terminals of the same polarity  | 2.5 kV |
|   |             | Between terminals of different polarities   | 4 kV   |
|   |             | Between other terminals and uncharged metallic parts  | 6 kV   |
| Insulation resistance                         |             | 100 MΩ min.   |        |
| Contact gap                                   |             | 2 x 2 mm min  |        |
| Vibration resistance                          | Malfunction | 10 to 55 Hz, 0.75-mm single amplitude   |        |
| Shock resistance                              | Destruction | 1,000 m/s <sup>2</sup> min.   |        |
|   | Malfunction | 300 m/s <sup>2</sup> min.   |        |
| Conditional short-circuit current             |             | 100 A (EN60947-5-1)   |        |
| Rated open thermal current (I <sub>th</sub> ) |             | 10 A (EN60947-5-1)  |        |
| Ambient temperature                           |             | Operating: -30°C to 70°C with no icing  |        |
| Ambient humidity                              |             | Operating: 95% max.   |        |
| Weight  |             | Approx. 96 g (D4NS-1CF)   |        |

**Note:** 1. The above values are initial values.

2. The Switch contacts can be used with either standard loads or microloads. Once the contacts have been used to switch a load, however, they cannot be used to switch smaller loads. The contact surfaces will become rough once they have been used and contact reliability for smaller loads may be reduced.
3. The degree of protection is tested using the method specified by the standard (EN60947-5-1). Confirm that sealing properties are sufficient for the operating conditions and environment beforehand. Although the switch box is protected from dust or water penetration, do not use the D4NS in places where foreign material may enter through the key hole on the head, otherwise Switch damage or malfunctioning may occur.
4. The durability is for an ambient temperature of 5°C to 35°C and an ambient humidity of 40% to 70%. For more details, consult your OMRON representative.
5. If the ambient temperature is greater than 35°C, do not pass the 3-A, 250-VAC load through more than 2 circuits.
6. These figures are minimum requirements for safe operation.
7. This value will vary with the switching frequency, environment, and reliability level. Confirm that correct operation is possible with the actual load beforehand.

# Connections

## ■ Contact Form (Diagrams Show State with Key Inserted)

| Model    | Contact     | Contact form | Operating pattern | Remarks   |
|----------|-------------|--------------|-------------------|---|
| D4NS-□A□ | 1NC/1NO     |              |                   | Only NC contacts 11-12 have an approved direct opening mechanism. (→)<br>The terminals 11-12 and 33-34 can be used as unlike poles.                           |
| D4NS-□B□ | 2NC         |              |                   | Only NC contacts 11-12 and 31-32 have an approved direct opening mechanism. (→)<br>The terminals 11-12 and 31-32 can be used as unlike poles.                 |
| D4NS-□C□ | 2NC/1NO     |              |                   | Only NC contacts 11-12 and 21-22 have an approved direct opening mechanism. (→)<br>The terminals 11-12, 21-22, and 33-34 can be used as unlike poles.         |
| D4NS-□D□ | 3NC         |              |                   | Only NC contacts 11-12, 21-22, and 31-32 have an approved direct opening mechanism. (→)<br>The terminals 11-12, 21-22, and 31-32 can be used as unlike poles. |
| D4NS-□E□ | 1NC/1NO MBB |              |                   | Only NC contacts 11-12 have an approved direct opening mechanism. (→)<br>The terminals 11-12 and 33-34 can be used as unlike poles.                           |
| D4NS-□F□ | 2NC/1NO MBB |              |                   | Only NC contacts 11-12 and 21-22 have an approved direct opening mechanism. (→)<br>The terminals 11-12, 21-22 and 33-34 can be used as unlike poles.          |

**Note:** MBB (Make Before Break) contacts have an overlapping structure, so that before the normally closed contact (NC) opens, the normally open contact (NO) closes.

## Nomenclature

### ■ Structure

D4NS-□A□, D4NS-□B□, D4NS-□E□

D4NS-□C□, D4NS-□D□, D4NS-□F□

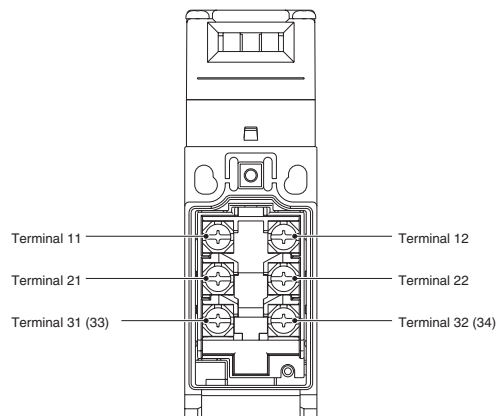
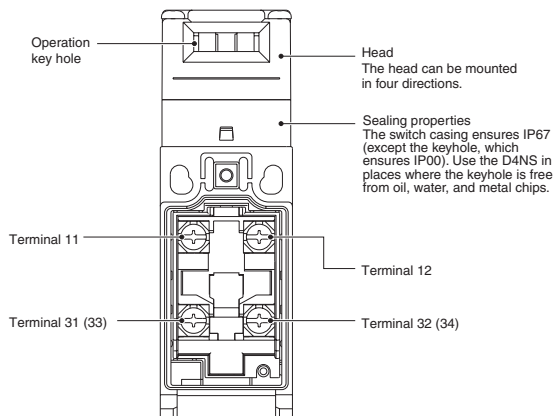

**Note:** The 2-conduit models have the same terminal arrangement.

# Dimensions

Note: All units are in millimeters unless otherwise indicated.

## Switches

### 1-Conduit Models

- D4NS-1□F
- D4NS-2□F
- D4NS-3□F
- D4NS-4□F

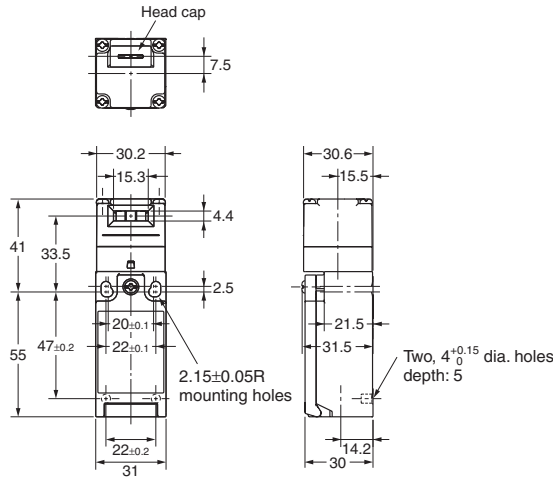
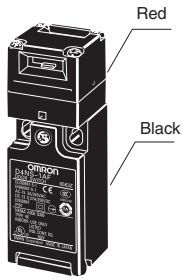

| Operating characteristics | D4NS-1□F<br>D4NS-2□F<br>D4NS-3□F<br>D4NS-4□F |
|---------------------------|--|
| Key insertion force       | 15 N max.                                    |
| Key extraction force      | 30 N max.                                    |
| Pretravel (PT)            | 6±3 mm                                       |
| Total travel (TT)         | (28 mm)                                      |
| Direct opening force*     | 60 N min.                                    |
| Direct opening stroke*    | 10 mm min.                                   |

\* Always maintain the above operating characteristics for safe use.

### 2-Conduit Models

- D4NS-5□F
- D4NS-6□F
- D4NS-7□F
- D4NS-8□F

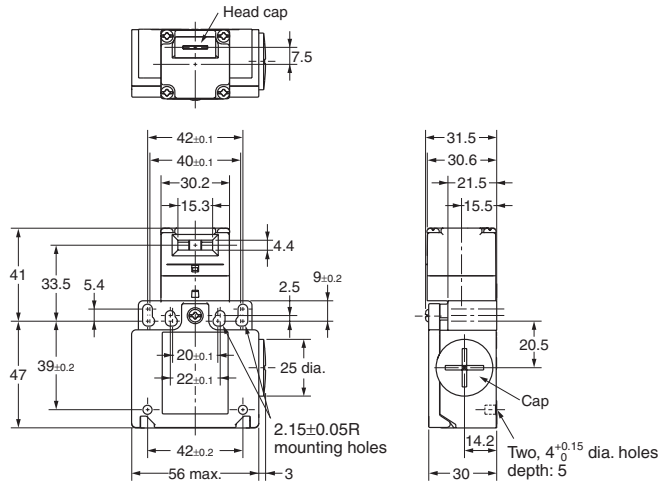
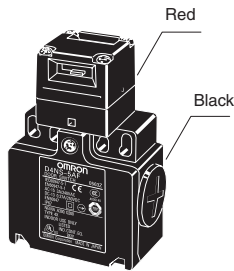

| Operating characteristics | D4NS-5□F<br>D4NS-6□F<br>D4NS-7□F<br>D4NS-8□F |
|---------------------------|--|
| Key insertion force       | 15 N max.                                    |
| Key extraction force      | 30 N max.                                    |
| Pretravel (PT)            | 6±3 mm                                       |
| Total travel (TT)         | (28 mm)                                      |
| Direct opening force*     | 60 N min.                                    |
| Direct opening stroke*    | 10 mm min.                                   |

\* Always maintain the above operating characteristics for safe use.

### 1-Conduit Connector Models

- D4NS-9□F

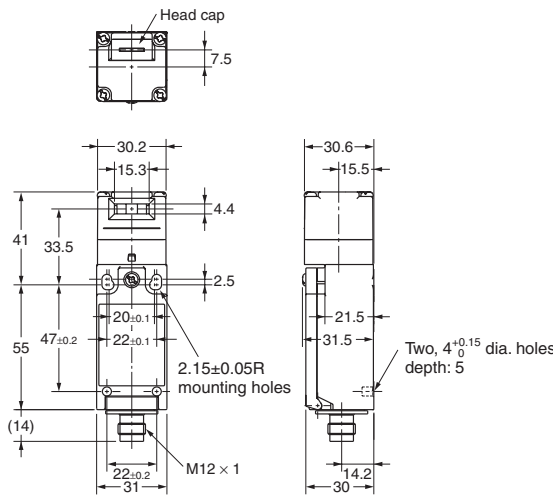
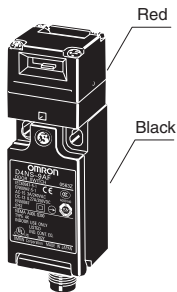

| Operating characteristics | D4NS-9□F   |
|---------------------------|------------|
| Key insertion force       | 15 N max.  |
| Key extraction force      | 30 N max.  |
| Pretravel (PT)            | 6±3 mm     |
| Total travel (TT)         | (28 mm)    |
| Direct opening force*     | 60 N min.  |
| Direct opening stroke*    | 10 mm min. |

\* Always maintain the above operating characteristics for safe use.

- Note: 1. Unless otherwise specified, a tolerance of ±0.4 mm applies to all dimensions.  
 2. There are fluctuations in the contact ON/OFF timing for Switches with multiple poles (2NC, 2NC/1NO, or 3NC). Confirm performance before application.

# ■ Operation Keys

**Note:** Unless otherwise specified, a tolerance of  $\pm 0.4$  mm applies to all dimensions.

**D4DS-K1**

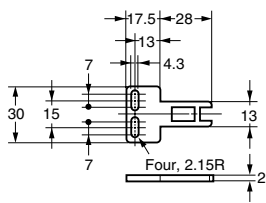

**D4DS-K3**

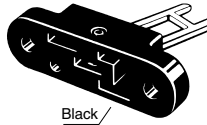

Black

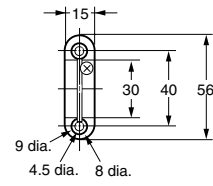
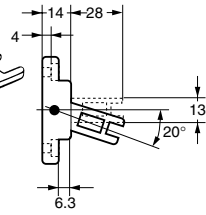

**D4DS-K2**

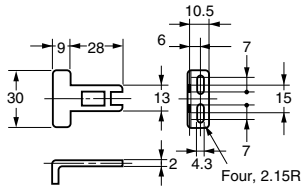
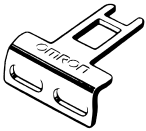

**D4DS-K5**

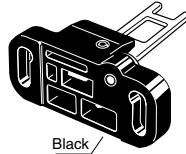

Black

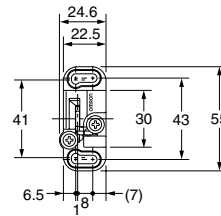
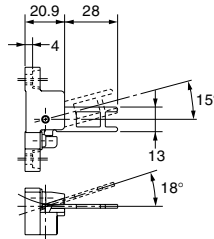

**Mounting Holes**

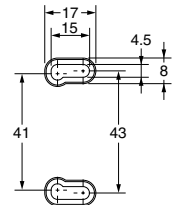

Safety Door Switches  
D4NS

# ■ With Operation Key Inserted (Relationship between Insertion Radius and Key Hole)

Note: Unless otherwise specified, a tolerance of  $\pm 0.4$  mm applies to all dimensions.

Safety Door Switches  
D4NS

D4NS-1□F + D4DS-K1

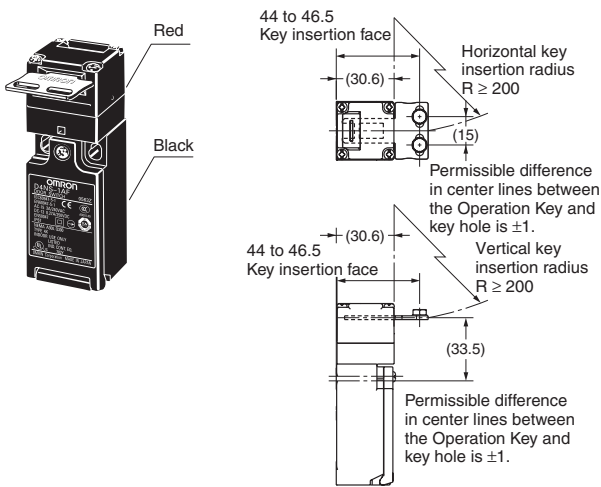

D4NS-1□F + D4DS-K2

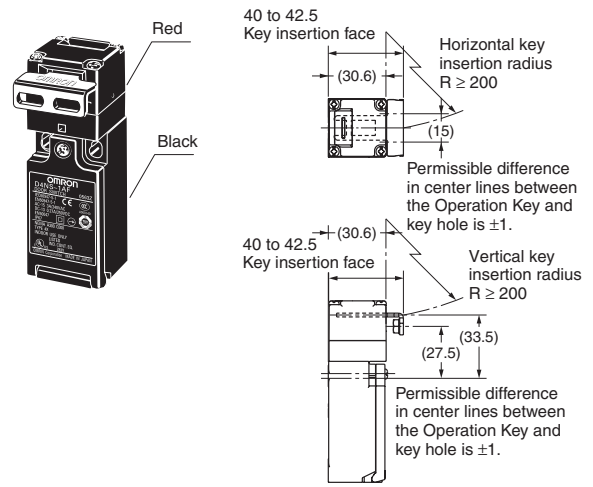

D4NS-1□F + D4DS-K3

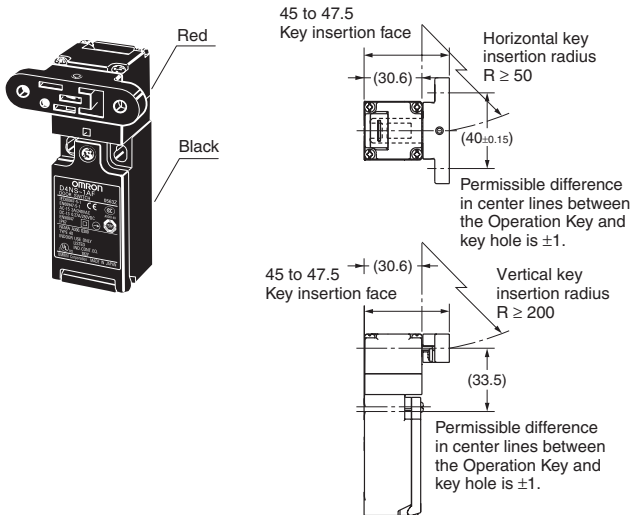

D4NS-1□F + D4DS-K5

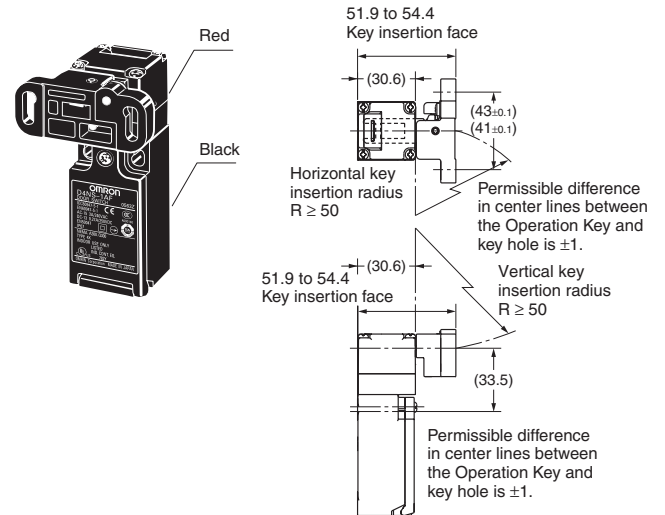

D4NS-1□F + D4NS-SK01

Switch Mounting Pattern 1

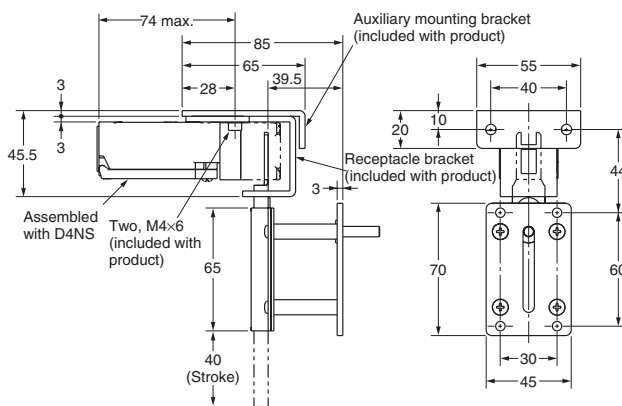

Switch Mounting Pattern 2

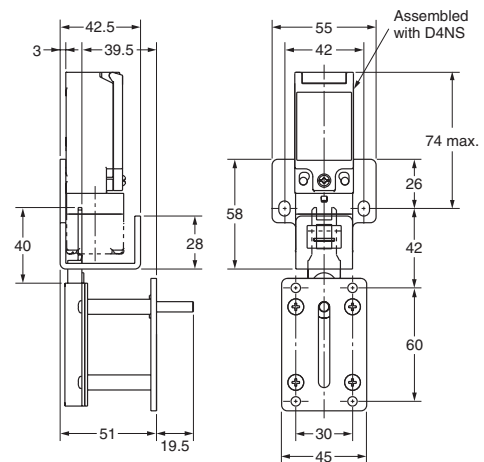



# Safety Precautions

Refer to the "Precautions for All Switches" on page I-2 and "Precautions for All Safety Door Switches" on page A-2.

## ■ Precautions for Safe Use

- Never disassemble or modify your D4NS in any way, or the D4NS will not operate normally.
- Do not use the Switch submersed in oil or water or in locations continuously subject to splashes of oil or water. Doing so may result in oil or water entering the Switch. (The IP67 degree of protection of the Switch specifies the amount of water penetration after the Switch is submerged in water for a certain period of time.)
- Although the switch body is protected from the ingress of dust or water, avoid the ingress of foreign substance through the key hole on the head. Otherwise, accelerated wear or breaking may result.
- Always be sure that the power supply is turned OFF while wiring the Switch.
- Always attach the cover after completing wiring and before using the Switch. Electric shock may occur if the Switch is used without the cover attached.
- Connect a fuse in series with the D4NS to protect it from short-circuit damage. The value of the breaking current of the fuse must be calculated by multiplying the rated current by 150% to 200%. When using the D4NS for an EN rating, use a 10-A fuse of type gI or gG that complies with IEC 60269.
- When switching general loads (250 VAC/3 A), do not operate two circuits or more at the same time. Otherwise, insulation performance may be degraded.

## Stopper Installation

Do not use a Switch as a stopper. Be sure to install a stopper as shown in the following illustration when mounting the Switch so that the base of the Operation Key does not strike the Head.

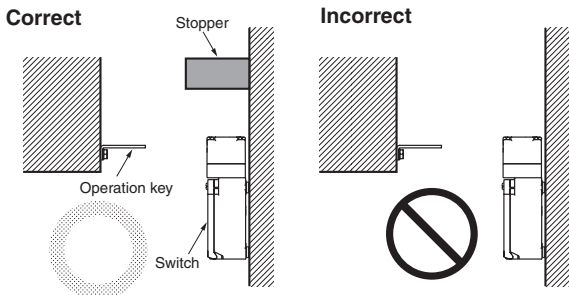

## ■ Precautions for Correct Use

The Switch contacts can be used with either standard loads or microloads. Once the contacts have been used to switch a load, however, they cannot be used to switch smaller loads. The contact surfaces will become rough once they have been used and contact reliability for smaller loads may be reduced.

## Mounting Method

### Tightening Torque

Loose screws may result in malfunction. Tighten the screws to the specified torques.

|   |                                   |
|---|-----------------------------------|
| Terminal screw                              | 0.6 to 0.8 N-m                    |
| Cover clamping screw                        | 0.5 to 0.7 N-m                    |
| Head clamping screw                         | 0.5 to 0.6 N-m                    |
| Operation Key clamping screw                | 2.4 to 2.8 N-m                    |
| Body clamping screw                         | 0.5 to 0.7 N-m                    |
| Conduit mounting connection and M12 adaptor | 1.8 to 2.2 N-m (except 1/2-14NPT) |
|   | 1.4 to 1.8 N-m (1/2-14NPT)        |
| Cap screw                                   | 1.3 to 1.7 N-m                    |

### Mounting Holes

- Use M4 screws and washers to mount the Switch and Operation Key, and tighten the screws to the proper tightening torque. For safety, use screws that cannot be easily removed or a similar means to prevent the Switch and Operation Key from being easily removed.
- As shown below, two studs with a maximum height of 4.8 mm and a diameter of  $4^{+0.05}_{-0.15}$  mm can be provided, the studs inserted into the holes on the bottom of the Switch, and the Switch secured at four locations to increase the mounting strength.

#### Switch Mounting Holes and Studs

- 1-Conduit Modules

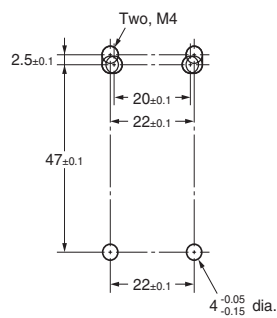

- 2-Conduit Modules

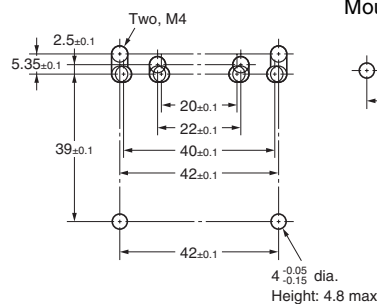

#### Operation Key Mounting Holes

- Horizontal/Vertical Mounting (D4DS-K1/-K2)

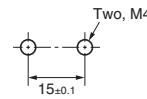

- Horizontal Adjustable Mounting (D4DS-K3)

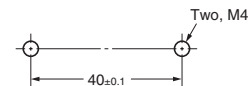

- Horizontal/Vertical Adjustable Mounting (D4DS-K5)

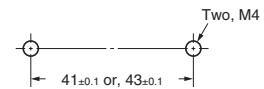

- Use the designated OMRON Operation Key with the Switch. Using another Operation Key may result in Switch damage.
- Set the Operation Key so that it is within 1 mm of the center of the key hole. If the Operation Key is offset or at an angle, accelerated wear or breaking may result.
- Observe the specified insertion radius for the Operation Key and insert it in a direction perpendicular to the key hole.

### Head Direction

- The rotation of the Switch head may be adjusted to any of the four directions by loosening the head clamping screws at the four corners of the head. Make sure that no foreign materials enter through the head.
- When changing the direction of the head, do so while the Operation Key is inserted.

### Securing the Door

When the door is closed (with the Operation Key inserted), it may be pulled beyond the set zone because of, for example, the door's weight, or the door cushion rubber. Also, if a load is applied to the Operation Key, the door may fail to unlock properly. Use hooks to ensure that the door stays within the set zone.

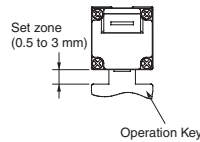

### Wiring

- When connecting with insulation tubes and M3.5 crimp terminals, connect the terminals as shown in the following figure and wire without overriding to the case and the cover. Adequate conductor size is AWG 20 to AWG18 (0.5 to 0.75 mm<sup>2</sup>). Prepare lead wires using the lengths given in the following diagrams. If lead wires are too long, they will press against the cover causing the cover to not close properly.

1-Conduit Models with 3 Poles

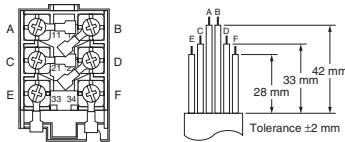

2-Conduit Models with 3 Poles

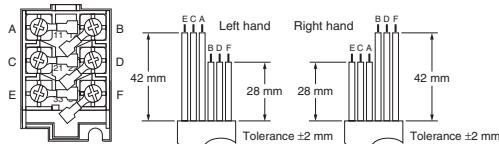

- Do not push the crimp terminal and the likes into the opening between the parts to prevent the case from being broken and deformed.
- Use terminals having the thickness of 0.5 mm or less to avoid the contact between the terminal and the Switch case inside.  
The terminals listed below have thickness of 0.5 mm or less.

| Manufacture    | Type   | Applicable lead wire size    |
|----------------|--|------------------------------|
| J.S.T. Mfg Co. | FV0.5-3.7 (F type)<br>V0.5-3.7 (straight type) | AWG20 (0.5 mm <sup>2</sup> ) |

J.S.T is a Japanese manufacturer.

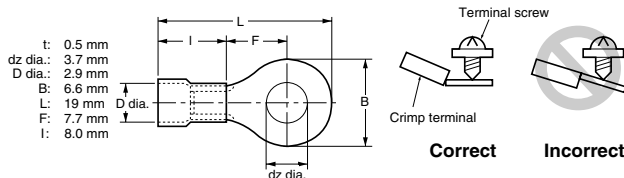

### Contact Arrangement

- The following show a safety contact and an auxiliary contact for 3 contacts and 2 contacts types.

(Screw terminal type)

D4NS-□DF (3NC)

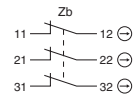

D4NS-□CF (2NC/1NO)

D4NS-□FF (2NC/1NO (MBB))

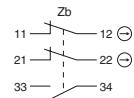

D4NS-□BF (2NC)

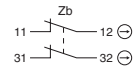

D4NS-□AF (1NC/1NO)

D4NS-□EF (1NC/1NO (MBB))

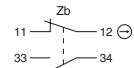

D4NS-9BF (2NC)

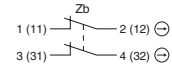

(Connector type)



D4NS-9AF (1NC/1NO)

D4NS-9EF (1NC/1NO (MBB))

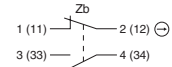

Pin No. (Terminal No.)

Suitable socket is Type XS2F (OMRON).

- Refer to the Connector Catalog for corresponding Socket pin numbers and lead wire colors.

### Socket Tightening (Models with Connectors)

- Turn the tightening screws on the Socket by hand and tighten them until the gap between the Socket and Plug essentially disappears.
- Make sure, however, that the Socket's connector is tightened securely, otherwise the rated degree of protection (IP67) of the D4NS may not be maintained. Furthermore, the Socket connector may be loosened by vibration.

### Conduit Opening

- When using 1/2-14NPT conduits, apply sealing tape between the connector and conduit opening to maintain the degree of protection (IP67) of the Switch.
- Use cables with suitable diameters for the connector being used.
- When wiring, place the enclosed cap screw on unused conduit openings (for 2-Conduit Switches) and tighten them to the suitable tightening torque.

## Recommended Connectors

Use the connector with thread section of 9 mm long or less. In the case of the connector with longer thread section, protruded part may interfere with the other parts inside the body. Use below listed connector to secure IP67.

| Size      | Manufacture | Type                      | Adequate cable diameter |
|-----------|-------------|---------------------------|-------------------------|
| G1/2      | LAPP        | ST-PF1/2<br>5380-1002     | 6.0 to 12.0 mm          |
| Pg13.5    | LAPP        | S-13.5<br>5301-5030       | 6.0 to 12.0 mm          |
| M20       | LAPP        | ST-M20 × 1.5<br>5311-1020 | 7.0 to 13.0 mm          |
| 1/2-14NPT | LAPP        | ST-NPT1/2<br>5301-6030    | 6.0 to 12.0 mm          |

When use LAPP's products, use together with a Seal Packing which is sold separately (Type names, JPK-16, GP-13.5, GPM20. GPM12 is for M12 connector) and tighten with proper tightening torque.

LAPP is a German manufacturer.

Before using the 2 conduit type 1/2-14NPT connector, attach the appended changing adapter to the Switch, and wind the seal tape about the joint of the adapter and Switch.

When use M12 conduit type, connect the above listed connector, after tightened the M12 changing adaptor to the Switch.

Safety Door Switches

D4NS

# Production Discontinuation

Following the release of the D4NS, production of the D4DS will be discontinued.

## Date of Production Discontinuation

Production of the D4DS Series will be discontinued as of the end of March 2006.

## Date of Substitute Product Release

Sale of the D4NS Series commenced in July 2003.

## Product Replacement

1. Dimensions  
The D4DS and D4NS have basically the same structure, and use the same mounting method, Operation Keys, mounting hole and Operation Key insertion positions. The multi-contact structure and the extra 4 mm in length, however, are different.
2. Terminal Numbers  
For the 2-contact model, the terminals 21, 22, 23, and 24 on the D4DS are 31, 32, 33, and 34 on the D4NS.
3. Recommended Terminals  
If the recommended terminals are not used, the Switch may not be compatible. Make sure that the Switch is compatible with the terminals.

## Operation Key

- D4DS-K1
- D4DS-K2
- D4DS-K3
- D4DS-K5

All of the above Operation Keys can be used with the D4NS.

## Comparison of the D4DS and Substitute Products

|                           |                         |
|---------------------------|-------------------------|
| Model                     | D4NS-□                  |
| Switch color              | Very similar            |
| Dimensions                | Very similar            |
| Wiring/connection         | Significantly different |
| Mounting method           | Completely compatible   |
| Ratings/performance       | Very similar            |
| Operating characteristics | Very similar            |
| Operating method          | Completely compatible   |

## List of Recommended Substitute Products

### Switch

| D4DS product | Recommended substitute product |
|--------------|--------------------------------|
| D4DS-15FS    | D4NS-1AF                       |
| D4DS-25FS    | D4NS-2AF                       |
| D4DS-35FS    | D4NS-3AF                       |
| D4DS-55FS    | D4NS-5AF                       |
| D4DS-65FS    | D4NS-6AF                       |
| D4DS-1AFS    | D4NS-1BF                       |
| D4DS-2AFS    | D4NS-2BF                       |
| D4DS-3AFS    | D4NS-3BF                       |
| D4DS-5AFS    | D4NS-5BF                       |
| D4DS-6AFS    | D4NS-6BF                       |



# Terms and Conditions of Sale

1. **Offer; Acceptance.** These terms and conditions (these "Terms") are deemed part of all quotes, agreements, purchase orders, acknowledgments, price lists, catalogs, manuals, brochures and other documents, whether electronic or in writing, relating to the sale of products or services (collectively, the "Products") by Omron Electronics LLC and its subsidiary companies ("Omron"). Omron objects to any terms or conditions proposed in Buyer's purchase order or other documents which are inconsistent with, or in addition to, these Terms.
2. **Prices; Payment Terms.** All prices stated are current, subject to change without notice by Omron. Omron reserves the right to increase or decrease prices on any unshipped portions of outstanding orders. Payments for Products are due net 30 days unless otherwise stated in the invoice.
3. **Discounts.** Cash discounts, if any, will apply only on the net amount of invoices sent to Buyer after deducting transportation charges, taxes and duties, and will be allowed only if (i) the invoice is paid according to Omron's payment terms and (ii) Buyer has no past due amounts.
4. **Interest.** Omron, at its option, may charge Buyer 1-1/2% interest per month or the maximum legal rate, whichever is less, on any balance not paid within the stated terms.
5. **Orders.** Omron will accept no order less than \$200 net billing.
6. **Governmental Approvals.** Buyer shall be responsible for, and shall bear all costs involved in, obtaining any government approvals required for the importation or sale of the Products.
7. **Taxes.** All taxes, duties and other governmental charges (other than general real property and income taxes), including any interest or penalties thereon, imposed directly or indirectly on Omron or required to be collected directly or indirectly by Omron for the manufacture, production, sale, delivery, importation, consumption or use of the Products sold hereunder (including customs duties and sales, excise, use, turnover and license taxes) shall be charged to and remitted by Buyer to Omron.
8. **Financial.** If the financial position of Buyer at any time becomes unsatisfactory to Omron, Omron reserves the right to stop shipments or require satisfactory security or payment in advance. If Buyer fails to make payment or otherwise comply with these Terms or any related agreement, Omron may (without liability and in addition to other remedies) cancel any unshipped portion of Products sold hereunder and stop any Products in transit until Buyer pays all amounts, including amounts payable hereunder, whether or not then due, which are owing to it by Buyer. Buyer shall in any event remain liable for all unpaid accounts.
9. **Cancellation; Etc.** Orders are not subject to rescheduling or cancellation unless Buyer indemnifies Omron against all related costs or expenses.
10. **Force Majeure.** Omron shall not be liable for any delay or failure in delivery resulting from causes beyond its control, including earthquakes, fires, floods, strikes or other labor disputes, shortage of labor or materials, accidents to machinery, acts of sabotage, riots, delay in or lack of transportation or the requirements of any government authority.
11. **Shipping; Delivery.** Unless otherwise expressly agreed in writing by Omron:
  - a. Shipments shall be by a carrier selected by Omron; Omron will not drop ship except in "break down" situations.
  - b. Such carrier shall act as the agent of Buyer and delivery to such carrier shall constitute delivery to Buyer;
  - c. All sales and shipments of Products shall be FOB shipping point (unless otherwise stated in writing by Omron), at which point title and risk of loss shall pass from Omron to Buyer; provided that Omron shall retain a security interest in the Products until the full purchase price is paid;
  - d. Delivery and shipping dates are estimates only; and
  - e. Omron will package Products as it deems proper for protection against normal handling and extra charges apply to special conditions.
12. **Claims.** Any claim by Buyer against Omron for shortage or damage to the Products occurring before delivery to the carrier must be presented in writing to Omron within 30 days of receipt of shipment and include the original transportation bill signed by the carrier noting that the carrier received the Products from Omron in the condition claimed.
13. **Warranties.** (a) **Exclusive Warranty.** Omron's exclusive warranty is that the Products will be free from defects in materials and workmanship for a period of twelve months from the date of sale by Omron (or such other period expressed in writing by Omron). Omron disclaims all other warranties, express or implied. (b) **Limitations.** OMRON MAKES NO WARRANTY OR REPRESENTATION, EXPRESS OR IMPLIED, ABOUT NON-INFRINGEMENT, MERCHANTABILITY OR FITNESS FOR A PARTICULAR PURPOSE OF THE PRODUCTS. BUYER ACKNOWLEDGES THAT IT ALONE HAS DETERMINED THAT THE PRODUCTS WILL SUITABLY MEET THE REQUIREMENTS OF THEIR INTENDED USE. Omron further disclaims all warranties and responsibility of any type for claims or expenses based on infringement by the Products or otherwise of any intellectual property right. (c) **Buyer Remedy.** Omron's sole obligation hereunder shall be, at Omron's election, to (i) replace (in the form originally shipped with Buyer responsible for labor charges for removal or replacement thereof) the non-complying Product, (ii) repair the non-complying Product, or (iii) repay or credit Buyer an amount equal to the purchase price of the non-complying Product; provided that in no event shall Omron be responsible for warranty, repair, indemnity or any other claims or expenses regarding the Products unless Omron's analysis confirms that the Products were properly handled, stored, installed and maintained and not subject to contamination, abuse, misuse or inappropriate modification. Return of any Products by Buyer must be approved in writing by Omron before shipment. Omron Companies shall not be liable for the suitability or unsuitability or the results from the use of Products in combination with any electrical or electronic components, circuits, system assemblies or any other materials or substances or environments. Any advice, recommendations or information given orally or in writing, are not to be construed as an amendment or addition to the above warranty. See <http://oeweb.omron.com> or contact your Omron representative for published information.
14. **Limitation on Liability; Etc.** OMRON COMPANIES SHALL NOT BE LIABLE FOR SPECIAL, INDIRECT, INCIDENTAL, OR CONSEQUENTIAL DAMAGES, LOSS OF PROFITS OR PRODUCTION OR COMMERCIAL LOSS IN ANY WAY CONNECTED WITH THE PRODUCTS, WHETHER SUCH CLAIM IS BASED IN CONTRACT, WARRANTY, NEGLIGENCE OR STRICT LIABILITY. Further, in no event shall liability of Omron Companies exceed the individual price of the Product on which liability is asserted.
15. **Indemnities.** Buyer shall indemnify and hold harmless Omron Companies and their employees from and against all liabilities, losses, claims, costs and expenses (including attorney's fees and expenses) related to any claim, investigation, litigation or proceeding (whether or not Omron is a party) which arises or is alleged to arise from Buyer's acts or omissions under these Terms or in any way with respect to the Products. Without limiting the foregoing, Buyer (at its own expense) shall indemnify and hold harmless Omron and defend or settle any action brought against such Companies to the extent based on a claim that any Product made to Buyer specifications infringed intellectual property rights of another party.
16. **Property; Confidentiality.** Any intellectual property in the Products is the exclusive property of Omron Companies and Buyer shall not attempt to duplicate it in any way without the written permission of Omron. Notwithstanding any charges to Buyer for engineering or tooling, all engineering and tooling shall remain the exclusive property of Omron. All information and materials supplied by Omron to Buyer relating to the Products are confidential and proprietary, and Buyer shall limit distribution thereof to its trusted employees and strictly prevent disclosure to any third party.
17. **Export Controls.** Buyer shall comply with all applicable laws, regulations and licenses regarding (i) export of products or information; (ii) sale of products to "forbidden" or other proscribed persons; and (iii) disclosure to non-citizens of regulated technology or information.
18. **Miscellaneous.** (a) **Waiver.** No failure or delay by Omron in exercising any right and no course of dealing between Buyer and Omron shall operate as a waiver of rights by Omron. (b) **Assignment.** Buyer may not assign its rights hereunder without Omron's written consent. (c) **Law.** These Terms are governed by the law of the jurisdiction of the home office of the Omron company from which Buyer is purchasing the Products (without regard to conflict of law principles). (d) **Amendment.** These Terms constitute the entire agreement between Buyer and Omron relating to the Products, and no provision may be changed or waived unless in writing signed by the parties. (e) **Severability.** If any provision hereof is rendered ineffective or invalid, such provision shall not invalidate any other provision. (f) **Setoff.** Buyer shall have no right to set off any amounts against the amount owing in respect of this invoice. (g) **Definitions.** As used herein, "including" means "including without limitation"; and "Omron Companies" (or similar words) mean Omron Corporation and any direct or indirect subsidiary or affiliate thereof.

## Certain Precautions on Specifications and Use

1. **Suitability of Use.** Omron Companies shall not be responsible for conformity with any standards, codes or regulations which apply to the combination of the Product in the Buyer's application or use of the Product. At Buyer's request, Omron will provide applicable third party certification documents identifying ratings and limitations of use which apply to the Product. This information by itself is not sufficient for a complete determination of the suitability of the Product in combination with the end product, machine, system, or other application or use. Buyer shall be solely responsible for determining appropriateness of the particular Product with respect to Buyer's application, product or system. Buyer shall take application responsibility in all cases but the following is a non-exhaustive list of applications for which particular attention must be given:
  - (i) Outdoor use, uses involving potential chemical contamination or electrical interference, or conditions or uses not described in this document.
  - (ii) Use in consumer products or any use in significant quantities.
  - (iii) Energy control systems, combustion systems, railroad systems, aviation systems, medical equipment, amusement machines, vehicles, safety equipment, and installations subject to separate industry or government regulations.
  - (iv) Systems, machines and equipment that could present a risk to life or property. Please know and observe all prohibitions of use applicable to this Product.
 NEVER USE THE PRODUCT FOR AN APPLICATION INVOLVING SERIOUS RISK TO LIFE OR PROPERTY OR IN LARGE QUANTITIES WITHOUT ENSURING THAT THE SYSTEM AS A WHOLE HAS BEEN DESIGNED TO ADDRESS THE RISKS, AND THAT THE OMRON'S PRODUCT IS PROPERLY RATED AND INSTALLED FOR THE INTENDED USE WITHIN THE OVERALL EQUIPMENT OR SYSTEM.
2. **Programmable Products.** Omron Companies shall not be responsible for the user's programming of a programmable Product, or any consequence thereof.
3. **Performance Data.** Data presented in Omron Company websites, catalogs and other materials is provided as a guide for the user in determining suitability and does not constitute a warranty. It may represent the result of Omron's test conditions, and the user must correlate it to actual application requirements. Actual performance is subject to the Omron's Warranty and Limitations of Liability.
4. **Change in Specifications.** Product specifications and accessories may be changed at any time based on improvements and other reasons. It is our practice to change part numbers when published ratings or features are changed, or when significant construction changes are made. However, some specifications of the Product may be changed without any notice. When in doubt, special part numbers may be assigned to fix or establish key specifications for your application. Please consult with your Omron's representative at any time to confirm actual specifications of purchased Product.
5. **Errors and Omissions.** Information presented by Omron Companies has been checked and is believed to be accurate; however, no responsibility is assumed for clerical, typographical or proofreading errors or omissions.

Complete "Terms and Conditions of Sale" for product purchase and use are on Omron's website at [www.omron.com/oei](http://www.omron.com/oei) – under the "About Us" tab, in the Legal Matters section.

**ALL DIMENSIONS SHOWN ARE IN MILLIMETERS.**

To convert millimeters into inches, multiply by 0.03937. To convert grams into ounces, multiply by 0.03527.

---

**OMRON**<sup>®</sup>**OMRON ELECTRONICS LLC**

One Commerce Drive  
Schaumburg, IL 60173

**847-843-7900**

For US technical support or other inquiries:

**800-556-6766****OMRON CANADA, INC.**

885 Milner Avenue  
Toronto, Ontario M1B 5V8

**416-286-6465****OMRON ON-LINE**

Global - <http://www.omron.com>  
USA - <http://www.omron.com/oei>  
Canada - <http://www.omron.ca>